

WorkiMed PC Mini Cart

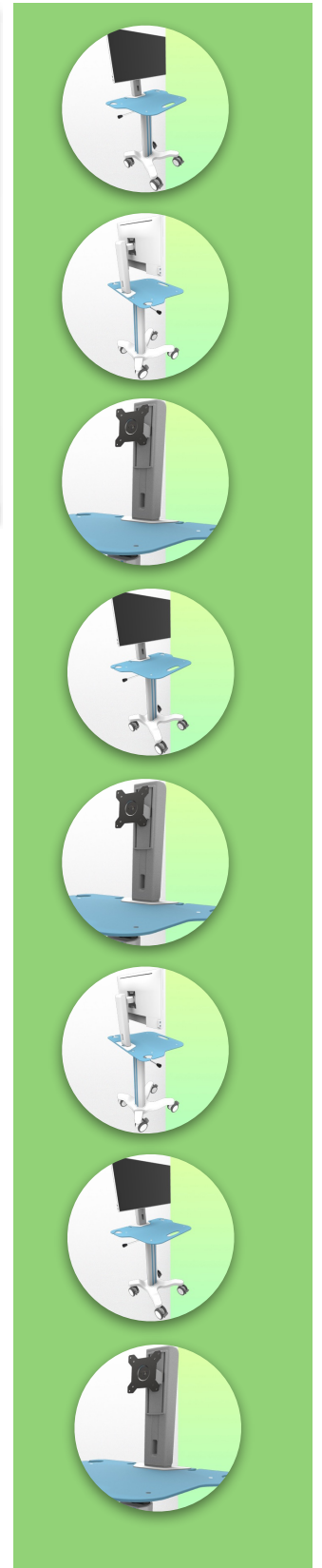
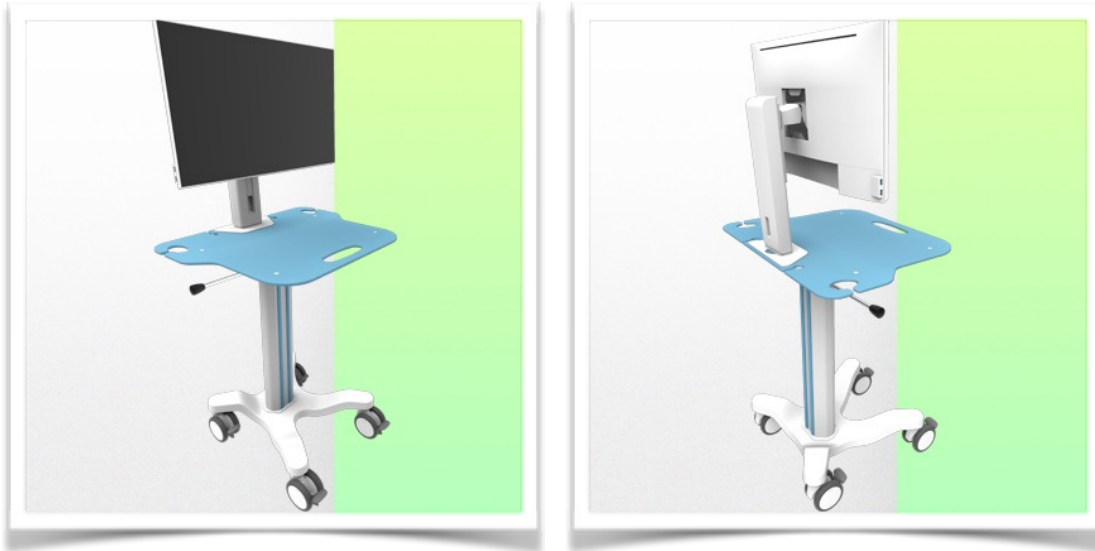

This new ergonomically designed medical trolley is height-adjustable by means of a hand lever located underneath the work surface. The hand lever activates the height adjustment mechanism, allowing the trolley to be raised and lowered from 770 mm to 1120 mm without any effort, simply by pressing the lever. The gas lift on the trolley provides smooth adjustment for all sizes and strengths of users, allowing for maximum comfort when sitting or standing.

Its lightweight and robust aluminium construction allows the new WorkiMed PC Mini Cart to be used for intensive movement without strain.

An open architecture provides access points throughout the surface, facilitating connections from the laptop to the keyboard and mouse.

The minimal footprint is also an advantage, measuring only 616mm at the base and 660 x 500mm at the work surface, allowing it to be moved even in tight spaces in the hospital.

The WorkiMed PC Mini Cart complies with hospital hygiene standards and can be disinfected down to the last detail, including the wheels, with no rough edges in its design for thorough and easy cleaning to help control infection.

The surface of the worktop is made of hard, shiny and highly impact-resistant acrylic glass. This synthetic material is virtually unbreakable: it is 250 times stronger than glass of the same thickness!

WorkiMed PC Mini Cart

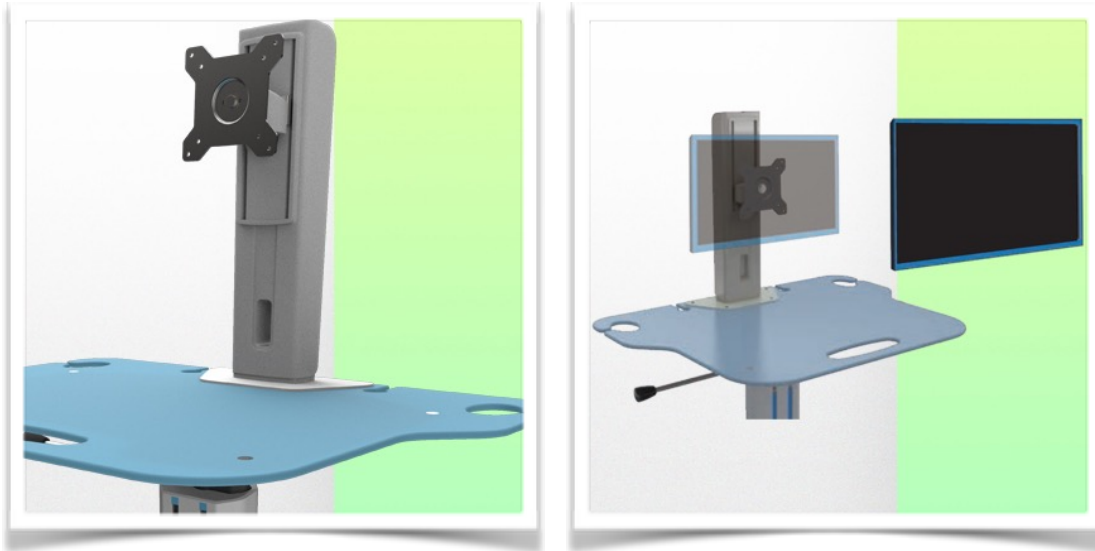

This new generation of height-adjustable, easy-to-move, hygienic medical computer trolley is perfect for any patient environment.

The ergonomic arm for screens up to 24" (VESA 75/100mm) is height adjustable by 13 cm and allows for 5° screen tilt and 25° right/left position. Full 360° screen rotation (Landscape).

The ergonomics of the worktop has not been forgotten, it includes in this new concept, a handle for transport, two supports for barcode reader on the left and right. On the back of the worktop there are also two integrated cable holders.

The central column is also equipped with a sliding support to adjust the height of your optional accessories such as a service basket.

The new WorkiMed PC Mini Cart is equipped with comfortable CE medical anti-static wheels, which can be manoeuvred effortlessly by the nursing staff at the point of care. The wheels have a diameter of 100 mm and are all equipped with a foot brake. These wheels allow the easy overcoming of bumps and imperfections in the floor.

A wide range of accessories allows this computerised medical trolley to evolve according to the specific needs of the user.

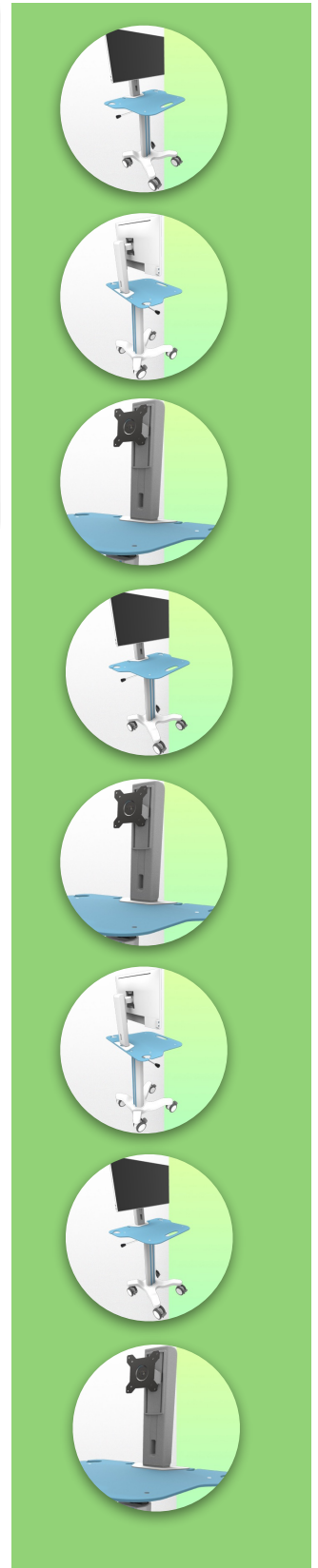



WorkiMed[®]
WORK PLACE TECHNOLOGY

Presentation

Part Number: WM 555.102

WorkiMed PC Mini Cart





WorkiMed[®]
WORK PLACE TECHNOLOGY

Presentation

Part Number: WM 555.102

WorkiMed PC Mini Cart

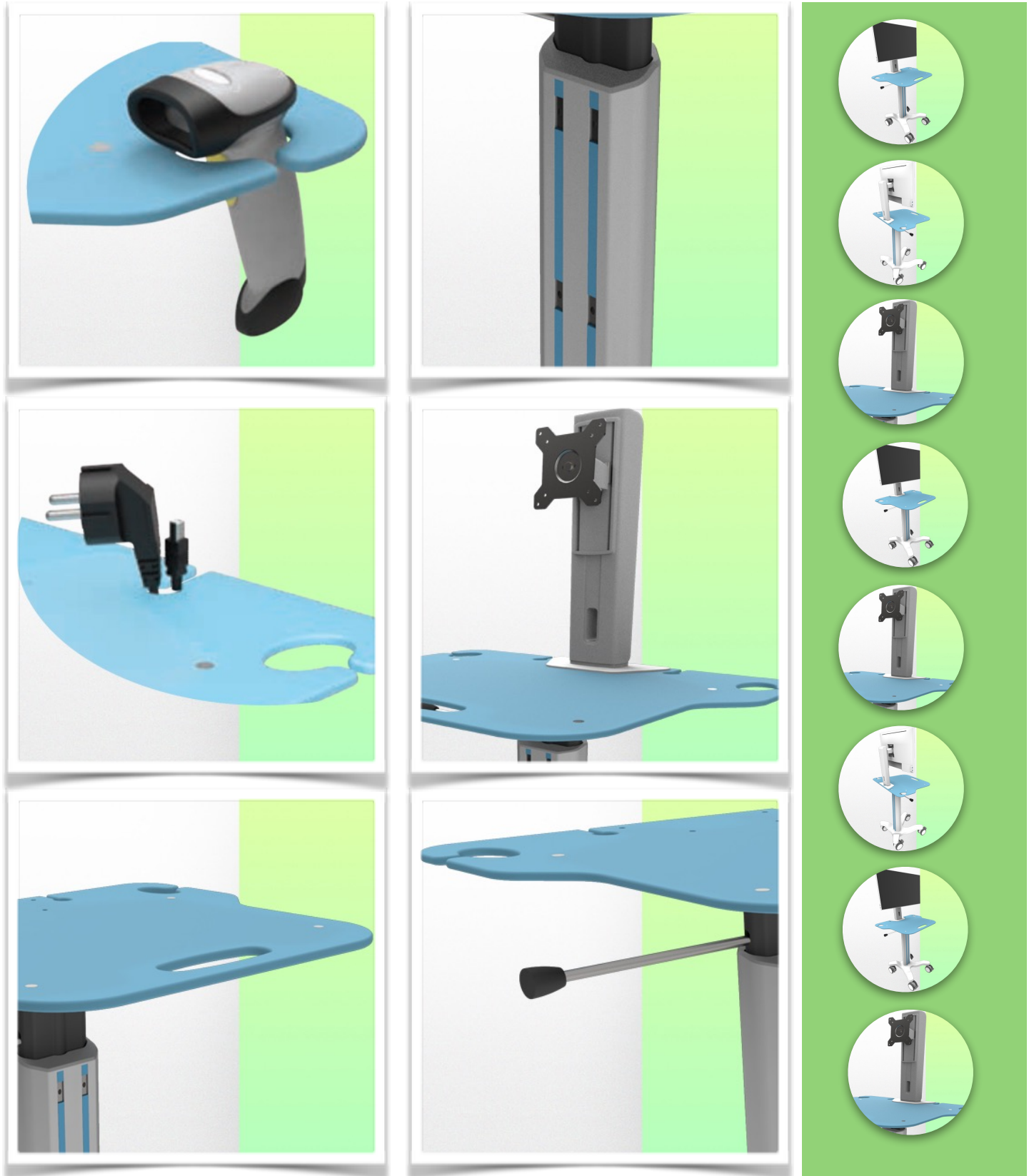



WorkiMed PC Mini Cart

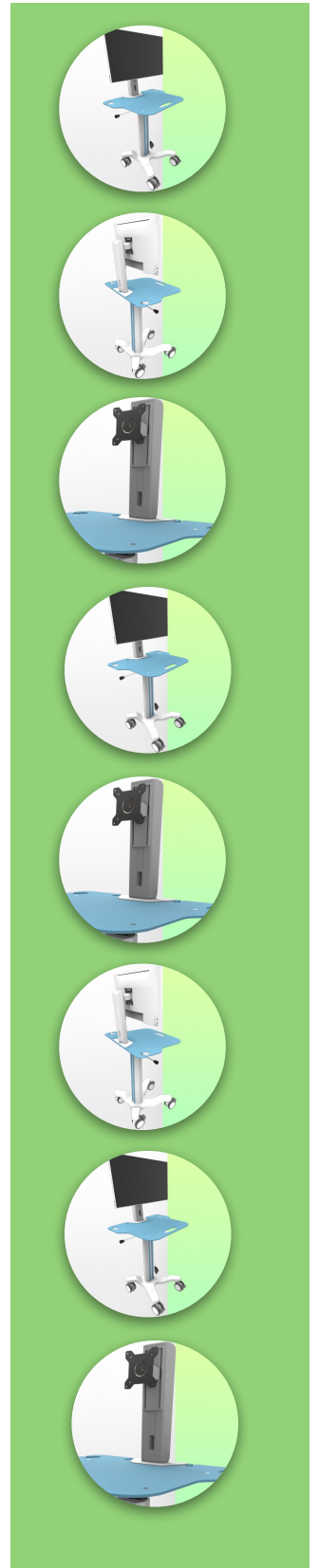
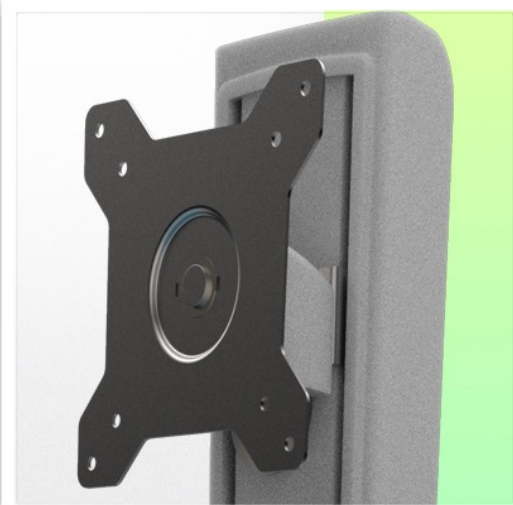
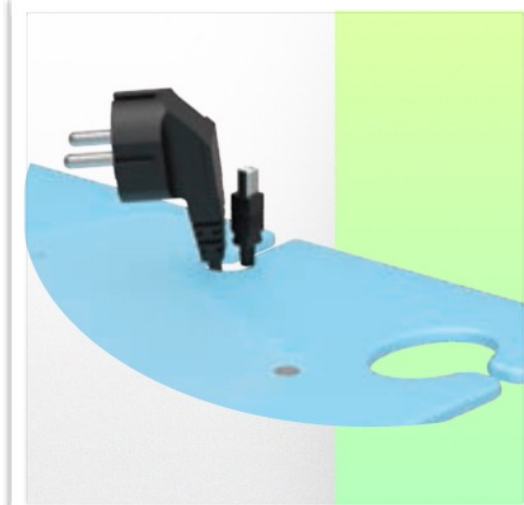
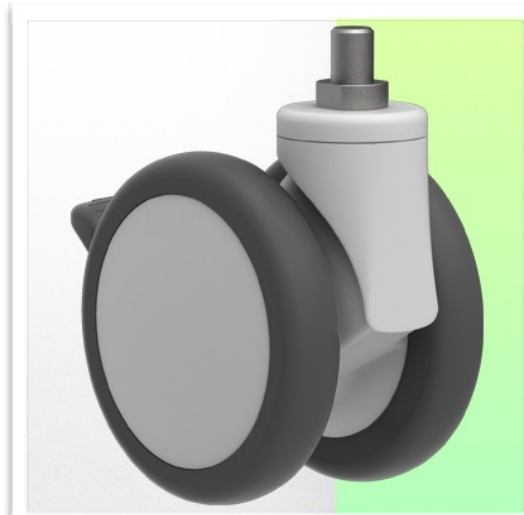



WorkiMed[®]
WORK PLACE TECHNOLOGY

Presentation

Part Number: WM 555.102

WorkiMed PC Mini Cart

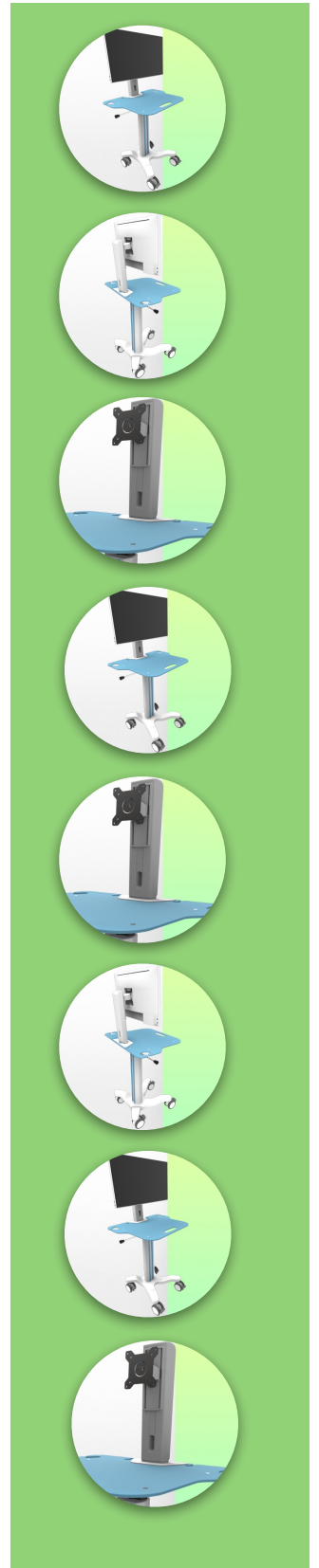
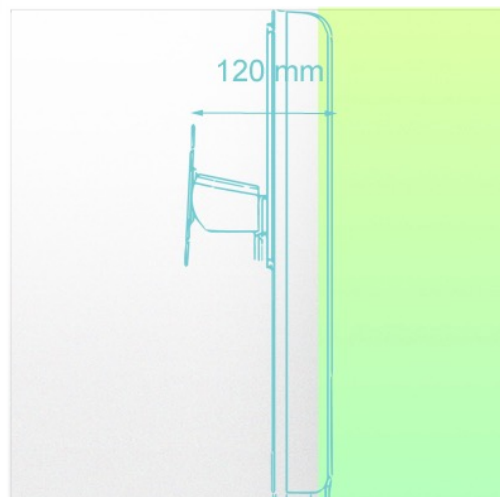
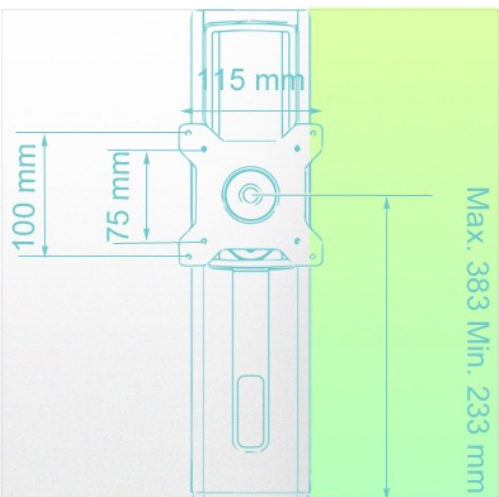
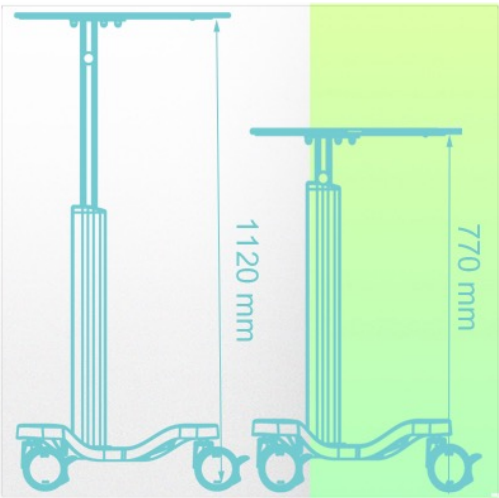
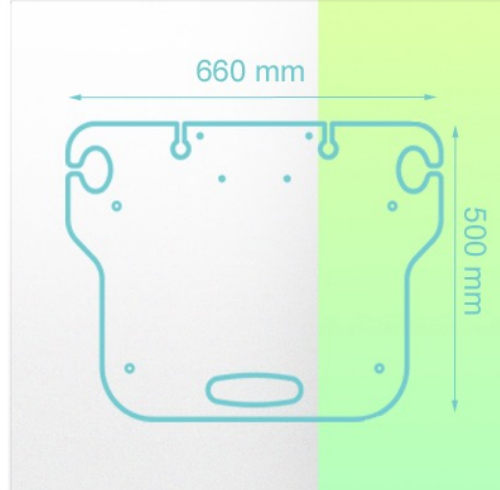
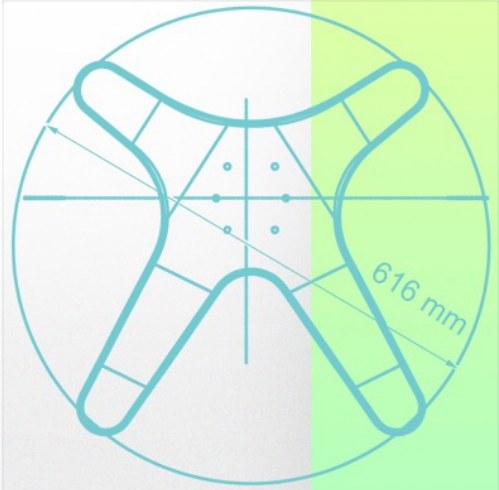

WorkiMed PC Mini Cart

Technical specifications:

- * High position: 1120 mm
 - * Low position: 770 mm
 - * Base diameter: 616 mm four legs
 - * Work surface: W 660 mm x D 500 mm
 - * Height adjustment capacity: 350 mm
 - * Wheel construction: Polyamide with polyurethane tread.
 - * Wheels/Lock: 4 locking wheels with brakes, 100 mm diameter
 - * Trolley weight: 18 Kg
 - * Loading capacity: 25 Kg
 - * Main assembly: Aluminium
 - * Work surface: Moulded Acrylic
 - * Colour: Ral 9016 White
 - * Ergonomic arm height adjustable by 13 cm
 - * VESA monitor support 75/100 mm, tilt by 5°
 - * Tilt right/left 25°
 - * Landscape 360° function
 - * Certificates are in accordance with : IEC60601-1: 2012 (Edition 3)
 - * CE/Rohs compliant
 - * Fully recyclable
 - * 10 year warranty
 - * Optional keyboard and mouse
 - * Wide range of accessories
 - * For faster and easier cleaning
 - * Simple and lightweight design for easy adjustment from sitting to standing.
 - * Supplied fully assembled with minimal packaging
 - * Made in Europe (MCC John Gough design and development)
- * We can also make custom made trolleys according to your needs and in your hospital colours as an option

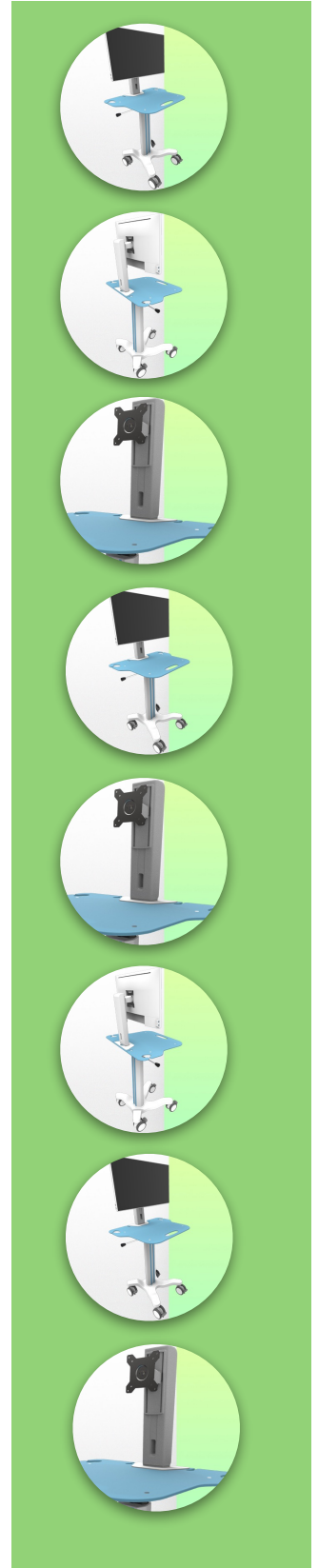

WorkiMed PC Mini Cart

Cleaning procedure

1. The trolley can be cleaned with most mild, non-abrasive solutions commonly used in hospitals (e.g. dilute bleach, ammonia or alcohol solutions).
2. The surface finish will be permanently damaged by strong chemicals and solvents such as acetone and trichloroethylene.
3. Do not use steel wool or other abrasive materials to clean the mounting assembly.
4. Damage caused by the use of unapproved substances or processes will not be covered by the warranty. We recommend that you test any cleaning solution on a small area that is not visible to check for compatibility.
5. Immediately wipe off any cleaning agent on the arm with a cloth dampened with water.
6. Dry the trolley thoroughly after cleaning.

CAUTION: WorkiWay SRL makes no claims regarding the effectiveness of the chemicals or processes listed as a means of infection control.

Consult your hospital infection control officer or epidemiologist. To clean or sterilize mounted instruments or accessories, refer to the specific instructions provided with those products.

