



Compatibilité écran: 30" - 57" (2)
Poids Supporté: 80 Kg
Norme VESA: 200, 300, 400, 400 x 200,
600 x 200, 600 x 400 mm
Centre de l'écran: 150 cm



30" - 57" (2)



200, 300, 400, 400 x 200,
600 x 200, 600 x 400 mm



80 Kg

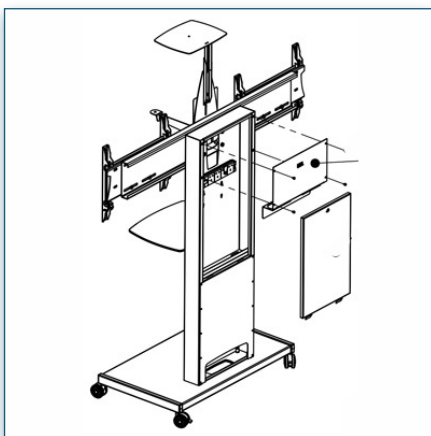
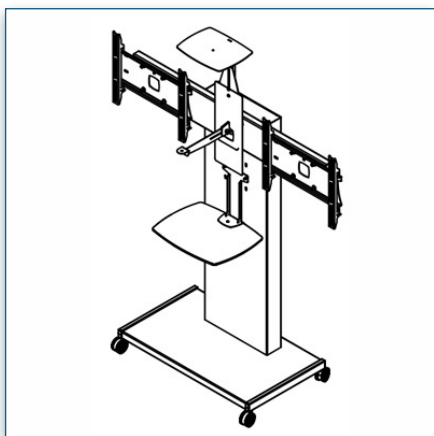

N'hésitez pas de nous contacter si vous avez des questions au sujet de cette gamme de produits.

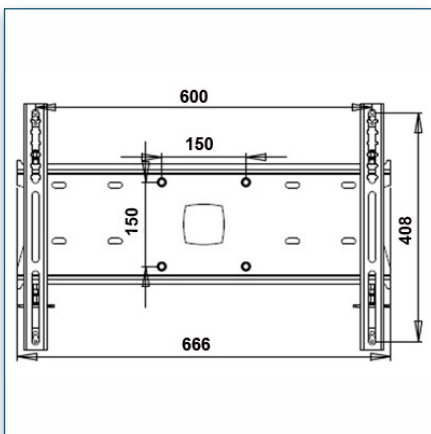
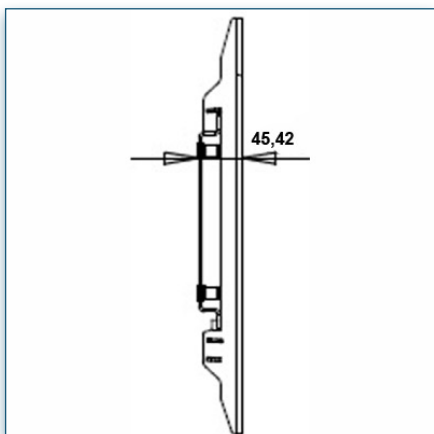

Garantie: 5 ans



000.440.818



Laqué Noir



-



-



440.818