

N'hésitez pas de nous contacter si vous avez des questions au sujet de cette gamme de produits.

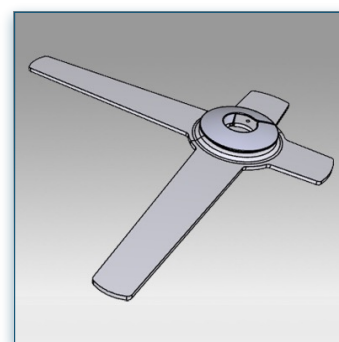

Garantie: 5 ans



000.158.010



Blanc



442 x 248 x 70 mm



2,11 Kg



158.010